

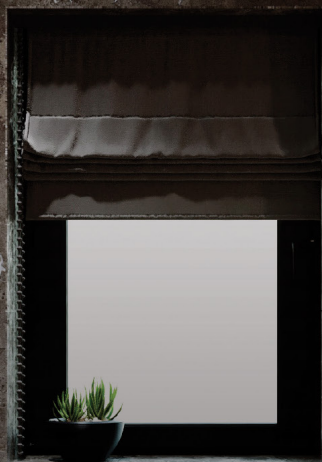

 **MARTEC**[®]
Heating

 **MARTEC**[®]
Exhaust



**BATHROOM HEATER &
EXHAUST FAN
CATALOGUE**

2026



WARRANTY GUIDE

Warranty details may vary by bathroom heater / exhaust fan model. Please refer to the specific product in this catalogue or visit our website for exact information.



2 YEAR
IN HOME WARRANTY

BATHROOM HEATER
3-IN-1 / 4-IN-1



2 YEAR
REPLACEMENT
WARRANTY

EXHAUST FAN &
EXHAUST FAN LED



1 YEAR
REPLACEMENT
WARRANTY

REMOTE CONTROL
ESSENCE
CONTOUR 1
UNO

WE DO MORE THAN YOU THINK

At Martec we not only offer fans but different solutions as well.



Martec® Cooling offers a versatile range of ceiling fans and wall fans. Our ceiling fan range features AC, DC, and Smart WiFi DC fans, designed to deliver efficient performance, quiet operation, and modern style for any space. With a variety of sizes, finishes, and control options available, Martec® offers solutions for every space.



To support different installation needs, Martec® also offers a range of compatible accessories, including extension down rods and angle canopies for sloped ceilings. Whether for small rooms or large open areas, Martec® delivers quality, energy-efficient cooling tailored to your needs.



Martec® Lighting offers a wide range of LED solutions, including downlights, surface-mounted fittings, and exterior lights. Our downlights and surface fixtures feature switchable colour temperatures and dimming options, compatible with Martec® dimmers for personalised ambiance.

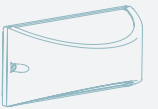

Our exterior lights come with various IP ratings and optional motion sensors, providing reliable safety and security for any outdoor space. Whether for small projects or large installations, Martec® delivers quality, budget-friendly lighting tailored to your needs.



MDA Lighting is a premium Australian-owned lighting brand celebrated for its high-class, decorative designs. With over a decade of industry experience, MDA offers an extensive range of stylish indoor and outdoor fixtures that suit both classic and contemporary spaces.

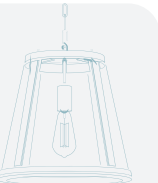

Their products are known for exceptional craftsmanship and unique, premium finishes such as acid-wash copper, silver leaf, and gilded gold. Each piece is designed to elevate interiors with timeless elegance, making MDA Lighting a go-to choice for sophisticated and statement lighting solutions.

Disclaimer: Martec is committed to ongoing development and enhancement of its products. Consequently, all descriptions, illustrations, drawings and specifications presented in this publication are intended as general information and do not form part of any contractual agreement. The figures related to air movements are indicative and should be considered as approximate values. All measurements are provided in millimeters unless stated otherwise. Please note that specifications and imagery are subject to change without prior notice. This information was last updated in April 2026.

IPX RATING

IP stands for Ingress Protection. The "X" simply means that the value for that number is missing. Therefore, the product has no protection against solids like dust and dirt.



I **P** **X** **4**
 Ingress Protection Not Tested For Solids Liquid Protection



0 No protection



5 Protected against low pressure water stream from any angle



1 Protected against condensation or dripping water falling vertically



6 Protected against high pressure water stream from any angle



2 Protected against spraying water when tilted up to 15° vertically



7 Protected against water immersion. Immersion for 30 minutes at a depth of up to 1 meter



3 Protected against spraying water when tilted up to 60° vertically



8 Protected against continual water submersion in under water conditions



4 Protected against splashing water from any angle

BATHROOM HEATER & EXHAUST FAN CALCULATOR

Note: This calculator is a guide only. It does not constitute specific advice from the Martec team. You should always check your local building codes and requirements before having a new bathroom heater and exhaust fan installed.

This calculator can be accessed via our website <https://www.martec.com.au/exhaust-fan-calculator/>

STEP 1:

Select installation location

Select Installation Location		
<input type="text" value="Bathroom"/>		
Enter your room width (m)	Enter your room length (m)	Enter your room height (m)
<input type="text"/>	<input type="text"/>	<input type="text"/>
Your room size in m3	From (m3/hr)	To (m3/hr)
<input type="text" value="0.00 m3"/>	<input type="text" value="0.00 m3/hr"/>	<input type="text" value="0.00 m3/hr"/>

STEP 2:

Enter your room size

Enter your room width (m)	Enter your room length (m)	Enter your room height (m)
<input type="text" value="3"/>	<input type="text" value="4"/>	<input type="text" value="2.4"/>
Your room size in m3	From (m3/hr)	To (m3/hr)
<input type="text" value="29 m3"/>	<input type="text" value="432 m3"/>	<input type="text" value="576 m3"/>

STEP 3:

Product suggestions based on your room size entered



HIGH EFFICIENCY DC MOTOR

Profile Panel DC 2 3-in-1 High Performance Heater Fan Exhaust with 12W Tricolour LED Light

Capacity: 460 m³/hr



HIGH EFFICIENCY DC MOTOR

Profile Panel DC 4 3-in-1 Bathroom Heater with 4 Heat Lamps, Exhaust Fan and Tricolour LED Light

Capacity: 460 m³/hr



Scan to view the calculator via our website

Enhance your living experience with Martec[®]

For over six decades, Martec[®] has led the way in delivering innovative cooling, lighting, heating and exhaust solutions. Our legacy of quality and performance continues with the launch of our latest advancements – designed to elevate comfort, simplify installation, and bring smart technology with every home.

High Performance DC 3 – in – 1 Bathroom Heaters delivers powerful and energy-efficient comfort with advanced DC motor technology for strong airflow and quieter operation. This range includes **Linux DC**, **Profile Plus DC**, **Profile Panel DC** and the newly released **Quasar DC**, featuring tricolour LED lighting, slimline profiles and high extraction performance. Providing reliable warmth, efficient ventilation and modern functionality for everyday comfort. Engineered for ultimate comfort and warmth, these heaters feature various IPX rating and finishes, ensuring they seamlessly complement any bathroom design.

In addition, we've launched the **Comet DC Exhaust Fan** designed to deliver efficient, high-performance ventilation. An effective solution for removing moisture, steam and odours, helping maintain a fresh and comfortable environment in bathrooms and laundries. Selected models also feature an integrated LED lighting option providing convenient ventilation and lighting solution.

The Martec[®] Promise

At Martec, we are driven by a deep commitment to quality, innovation and service excellence. Every product reflects our meticulous attention to detail and passion for delivering solutions that exceed expectations. We don't just create heaters – we deliver comfort, convenience, and peace of mind.

CONTENTS

BATHROOM HEATERS

NEW MODELS



Quasar DC
pg. 12



Quasar Mini DC
pg. 14



Thermo
pg. 26



Vapour DC
pg. 28



Furnace Mini
pg. 31



Linux DC
pg. 16



Linux Mini DC
pg. 18



Profile Panel DC
pg. 21



Profile Plus DC
pg. 22

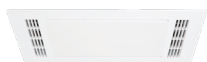

Furnace
pg. 30



Phoenix
pg. 32



Phoenix Mini
pg. 34



Aspire II
pg. 36



Forme
pg. 38



Striker
pg. 40



Essence
pg. 42



Contour
pg. 44



Uno
pg. 46

EXHAUST FANS

NEW



Core
p. 50

NEW



Comet DC
p. 52



Flow 240 / 295
p. 54



Saturn 240 / 295
p. 56

EXTERIOR HEATERS

NEW MODELS



Infrastrip
p. 60



Thermoheat
p. 62

ACCESSORIES

NEW



3-in-1 Bathroom Heater
Remote Control
p. 66

NEW



4-in-1 Bathroom Heater
Remote Control
p. 66

NEW



Run on Timer
p. 66



Lamps
p. 67



DC MOTOR BATHROOM HEATERS

Martec® offers a range of bathroom heaters powered by advanced DC motor technology, designed to deliver superior performance, improved energy efficiency, and quieter operation.

The DC motor enhances airflow and extraction performance while reducing power consumption, making it an ideal solution for modern, energy-conscious homes. Martec® products are available in a variety of styles and sizes to suit any design style, whether you're seeking a minimalist look or a more traditional aesthetic.

QUASAR DC

Registered Design

NEW

QUASAR DC

Sleek and modern

FEATURES

- Sleek and low profile design to suit any bathroom application
- Features a 20W or 24W Tricolour LED panel light
- Variable cutout for retro-fit (Quasar DC Mini Only)
- Polypropylene (PP) housing with polycarbonate (PC) fascia
- Built in thermal overload protection
- Efficient fan only / cooling function
- Back draft stopper included
- Cut-out template included
- Compatible with Martec Bathroom Remote MBHPTKIT (not included)



Matt White
MBHQ2200W

SPECIFICATIONS	QUASAR DC
AIR EXTRACTION m ³ /hr	360m ³ /hr
EXHAUST FAN WATTAGE	25W
VOLTAGE	220-240Va.c. 50Hz
MATERIALS	Polypropylene housing
CUTOUT SIZE	625 x 330mm
DECIBEL RATING	≤40dB
IP RATING	IPX4
HEATING WATTAGE / TYPE	2200W PTC
LIGHTING WATTAGE / TYPE	24W LED
COLOUR TEMPERATURE	3000K / 4000K / 5000K
LUMENS OUTPUT	1400lm / 1500lm / 1400lm
MINIMUM CEILING DEPTH	200mm
DUCTING SIZE	100mm
ACCESSORIES INCLUDED	1x 1.5m duct 2x clips for ducting 1x external grille 1x 4 gang switch wall controller

QUASAR MINI DC

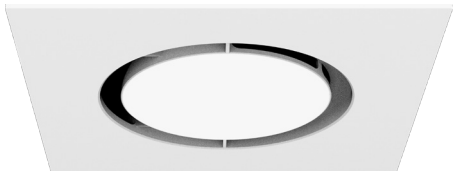

Matt White
MBHQM2200W

SPECIFICATIONS	QUASAR MINI DC
AIR EXTRACTION m ³ /hr	330m ³ /hr
EXHAUST FAN WATTAGE	25W
VOLTAGE	220-240Va.c. 50Hz
MATERIALS	Polypropylene housing
CUTOOUT SIZE	330 x 330mm Retro Fit Up to: 350 x 350mm
DECIBEL RATING	≤40dB
IP RATING	IPX4
HEATING WATTAGE / TYPE	2200W PTC
LIGHTING WATTAGE / TYPE	20W LED
COLOUR TEMPERATURE	3000K / 4000K / 5000K
LUMENS OUTPUT	1200lm / 1190lm / 1180lm
MINIMUM CEILING DEPTH	200mm
DUCTING SIZE	100mm
ACCESSORIES INCLUDED	1x 1.5m duct 2x clips for ducting 1x external grille 1x 4 gang switch wall controller

QUASAR DC

ACCESSORIES

4-in-1 Bathroom Heater Remote Control



ACCESSORIES	ORDERING CODE
4-in-1 Bathroom Heater Remote Control	MBHPTKIT

DIMENSIONS

QUASAR DC
MBHQ2200W

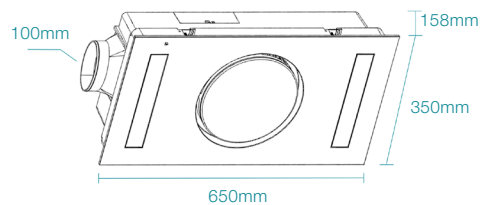

QUASAR MINI DC
MBHQM2200W

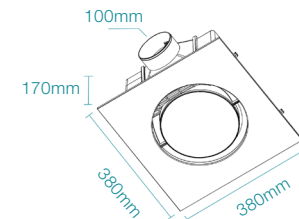

LINUX DC

Built for performance



FEATURES

- Sleek and low profile designed to suit any bathroom application
- High efficiency DC motor
- 3-in-1 bathroom heater features tricolour GU10 LED lamps with heat tube
- Steel housing with aluminium fascia
- Built in thermal overload protection
- Back draft stopper included
- Cut-out template included
- Compatible with Martec Bathroom Remote Control MBHRKIT (not included)

LINUX DC



Matt White
MBHLDC1000W

SPECIFICATIONS	LINUX DC
AIR EXTRACTION m ³ /hr	600m ³ /hr
EXHAUST FAN WATTAGE	25W
VOLTAGE	220-240Va.c. 50Hz
MATERIALS	Steel housing
CUTOUT SIZE	455 x 305mm
DECIBEL RATING	≤40dB
IP RATING	IPX4
HEATING WATTAGE / TYPE	1x 1000W R7s heat tube 238mm
LIGHTING WATTAGE / TYPE	4x 6W GU10 LED tricolour
COLOUR TEMPERATURE	3000K / 4000K / 5000K
LUMENS OUTPUT	2400lm
MINIMUM CEILING DEPTH	210mm
DUCTING SIZE	150mm
ACCESSORIES INCLUDED	1x 3m duct 2x clips for ducting 1x external grille 1x 3 gang switch wall controller 1x heat tube 4x LED lamps

LINUX MINI DC



Matt White
MBHMDC1000W

SPECIFICATIONS	LINUX MINI DC
AIR EXTRACTION m ³ /hr	480m ³ /hr
EXHAUST FAN WATTAGE	25W
VOLTAGE	220-240Va.c. 50Hz
MATERIALS	Steel housing
CUTOOUT SIZE	350 x 305mm
DECIBEL RATING	≤40dB
IP RATING	IPX4
HEATING WATTAGE / TYPE	1x 1000W R7s heat tube 238mm
LIGHTING WATTAGE / TYPE	3x 6W GU10 LED tricolour
COLOUR TEMPERATURE	3000K / 4000K / 5000K
LUMENS OUTPUT	1800lm
MINIMUM CEILING DEPTH	230mm
DUCTING SIZE	125mm
ACCESSORIES INCLUDED	1x 3m duct 2x clips for ducting 1x external grille 1x 3 gang switch wall controller 1x heat tube 3x LED lamps

LINUX DC

ACCESSORIES



1000W R7s Heat Tube 238mm

6W GU10 LED Tricolour

3-in-1 Bathroom Heater Remote Control

ACCESSORIES	ORDERING CODE
1000W R7s Heat Tube 238mm	MRLP1000W
6W GU10 LED Tricolour Lamp	MBGU34506
3-in-1 Bathroom Heater Remote Control	MBHRKIT

DIMENSIONS

LINUX DC
MBHLDC1000W

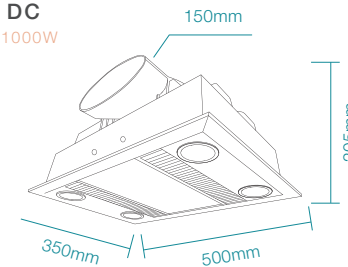

LINUX MINI DC
MBHMDC1000W

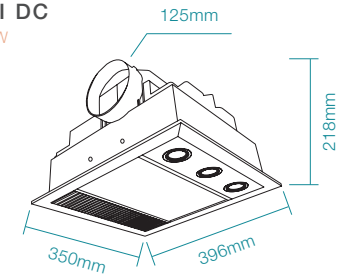



PROFILE DC

Efficiency redefined



2 YEAR
In-Home
Warranty



IPX4
Ingress
Protection



Heat Lamp



Ball Bearing
DC Motor



High
Extraction



Ultra Low
Profile



Tricolour



Class I

FEATURES

- Low profile designed to suit any bathroom application
- High efficiency DC motor
- Polypropylene (PP) housing with polycarbonate (PC) fascia
- Built in thermal overload protection
- Back draft stopper included
- Half heat function (4 heat unit only)
- Cut-out template included
- Compatible with Martec Bathroom Remote Control MBHRKIT (not included)

PROFILE PANEL DC



Matt White
MBHN2LW



Matt White
MBHN4LW

SPECIFICATIONS	PROFILE PANEL DC 2	PROFILE PANEL DC 4
AIR EXTRACTION m ³ /hr		460m ³ /hr
EXHAUST FAN WATTAGE		25W
VOLTAGE / FREQUENCY		220-240Va.c. 50Hz
MATERIALS / HOUSING		Polypropylene housing
CUTOUT SIZE	435 x 255mm	435 x 275mm
DECIBEL RATING		≤50dB
IP RATING		IPX4
HEATING WATTAGE / TYPE	2 x 275W heat lamps	4 x 275W heat lamps
LIGHTING WATTAGE / TYPE		12W LED
COLOUR TEMPERATURE		3000K / 4000K / 5000K
LUMENS OUTPUT		850lm / 900lm / 950lm
MINIMUM CEILING DEPTH		220mm
DUCTING SIZE		120mm
ACCESSORIES INCLUDED	1x 3m duct 2x clips for ducting 1x external grille 1x 3 gang switch wall controller 2x heat lamps 1x LED panel	1x 3m duct 2x clips for ducting 1x external grille 1x 4 gang switch wall controller 4x heat lamps 1x LED panel

PROFILE PLUS DC



Matt White
MBHP2LW



Matt White
MBHP4LW

SPECIFICATIONS	PROFILE PLUS DC 2	PROFILE PLUS DC 4
AIR EXTRACTION m ³ /hr		460m ³ /hr
EXHAUST FAN WATTAGE		25W
VOLTAGE / FREQUENCY		220-240Va.c. 50Hz
MATERIALS / HOUSING		Polypropylene housing
CUTOOUT SIZE	435 x 255mm	435 x 275mm
DECIBEL RATING		≤50dB
IP RATING		IPX4
HEATING WATTAGE / TYPE	2 x 275W heat lamps	4 x 275W heat lamps
LIGHTING WATTAGE / TYPE	3 x 6W GU10 LED tricolour	4 x 6W GU10 LED tricolour
COLOUR TEMPERATURE	3000K / 4000K / 5000K	3000K / 4000K / 5000K
LUMENS OUTPUT	1800lm	2400lm
MINIMUM CEILING DEPTH		220mm
DUCTING SIZE		120mm
ACCESSORIES INCLUDED	1x 3m duct 2x clips for ducting 1x external grille 1x 3 gang switch wall controller 2x heat lamps 3x GU10 lamps	1x 3m duct 2x clips for ducting 1x external grille 1x 4 gang switch wall controller 4x heat lamps 4x GU10 lamps

PROFILE DC

ACCESSORIES



ACCESSORIES	ORDERING CODE
275W E27 Heat Lamp	MRL275W
6W GU10 LED Tricolour Lamp	MBGU34506
3-in-1 Bathroom Heater Remote Control	MBHRKIT

DIMENSIONS

PROFILE PANEL/PLUS 2 DC

MBHN2LW
MBHP2LW

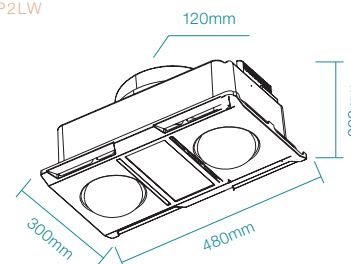

PROFILE PANEL/PLUS 4 DC

MBHN4LW
MBHP4LW

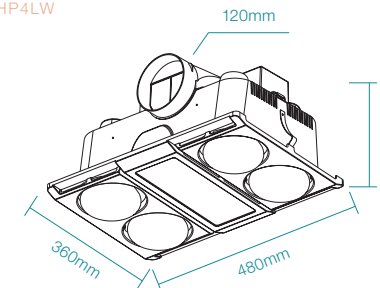



BATHROOM HEATERS

Martec® offers a wide range of bathroom heaters, available in various shapes and sizes to suit different needs and preferences. From simple single heat lamp units to slimline 3-in-1 heaters, our products are designed to deliver efficient warmth and comfort in any bathroom.

With a variety of IPX ratings and colour finishes, our heaters are versatile enough to complement any design scheme, whether you're looking for something sleek and modern or something more classic. Whatever your bathroom's size or aesthetic, Martec® has a solution that will fit seamlessly into your home.

NEW

THERMO

Redefine Bathroom Heating



2 YEAR Replacement Warranty



IPX2 Ingress Protection



2200W PTC Heating



High Performance Ball Bearing Motor



Ultra Low Profile



Touch Button Control

FEATURES

- Sleek and low profile design to suit any bathroom application
- Optional towel rack
- Easy to use with touch buttons
- Live temperature display
- Half heat function
- Adjustable timer function ranging from 5 to 90 minutes
- Maintains consistent heating temperature between 20° to 45°
- Oscillating air outlet for even airflow distribution
- Installation template included
- Designed for easy installation and maintenance

THERMO



Matt White
MBHT2200W

SPECIFICATIONS	THERMO
VOLTAGE	220-240Va.c. 50Hz
MATERIALS	Polypropylene housing
DECIBEL RATING	≤45dB
IP RATING	IPX2
HEATING WATTAGE / TYPE	2200W PTC
COOLING WATTAGE	2x 30W
TIMER	5 - 90 minutes
TEMPERATURE SETTINGS	20 - 45 degrees
ACCESSORIES INCLUDED	2x Mounting Bracket 1x Screw Pack 1x Installation Drilling Template 1x Towel Rail Kit

DIMENSIONS

THERMO

MBHT2200W

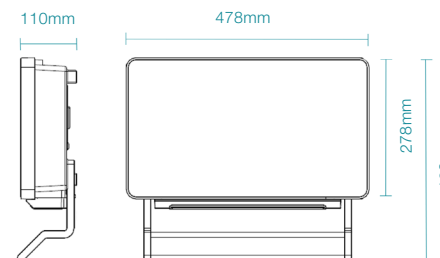

NEW

VAPOUR DC

Feature rich and efficient

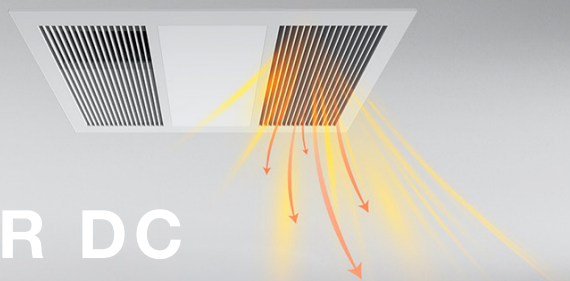

2 YEAR In-Home Warranty	IPX2 Ingress Protection	2200W PTC Heating	High Performance DC Motor
High Extraction	Ultra Low Profile	Tricolour	Low noise

FEATURES

- Sleek and low profile design to suit any bathroom application
- Features a 20W Tricolour LED panel light
- Polypropylene (PP) housing with polycarbonate (PC) fascia
- Built in thermal overload protection
- Back draft stopper included
- Cut-out template included
- Designed for easy installation and maintenance

VAPOUR DC



Matt White
MBHVDC2200W

SPECIFICATIONS	VAPOUR DC
AIR EXTRACTION m ³ /hr	600m ³ /hr
POWER WATTAGE	50W
VOLTAGE	220-240Va.c. 50Hz
MATERIALS	Polypropylene housing
CUTOUT SIZE	523 x 343mm
DECIBEL RATING	≤45dB
IP RATING	IPX2
HEATING WATTAGE / TYPE	2200W PTC
LIGHTING WATTAGE / TYPE	20W LED
COLOUR TEMPERATURE	3000K / 4000K / 5000K
LUMENS OUTPUT	Up to 2000lm
MINIMUM CEILING DEPTH	200mm
DUCTING SIZE	150mm
ACCESSORIES INCLUDED	1x 1.5m duct 1x external grille 1x 4 gang switch wall controller

DIMENSIONS

VAPOUR
MBHVDC2200W

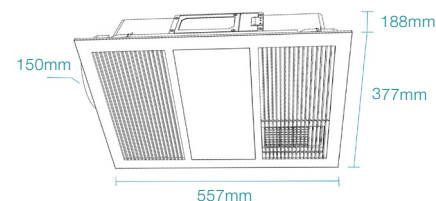

ACCESSORIES

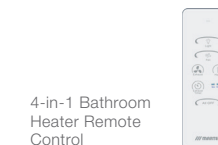

4-in-1 Bathroom Heater Remote Control

ACCESSORIES	ORDERING CODE
4-in-1 Bathroom Heater Remote Control	MBHPTKIT

NEW
FURNACE

Registered Design

All-in-one features in a compact form

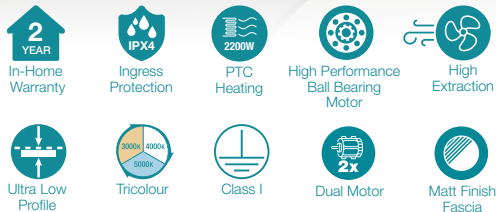

FEATURES

- Sleek and low profile designed to suit any bathroom application
- Variable cutout for retro-fit (Furnace Mini Only)
- Polypropylene (PP) housing with polycarbonate (PC) fascia
- Features a dedicated 18W Tricolour LED panel light
- Built in thermal overload protection
- Efficient fan only / cooling function
- Back draft stopper included
- Cut-out template included
- Compatible with Martec Bathroom Remote MBHPTKIT (not included)

FURNACE

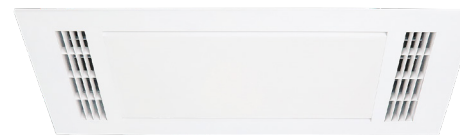

Matt White
MBHF2200W

NEW



Matt White
MBHFM2200W

SPECIFICATIONS	FURNACE	FURNACE MINI
AIR EXTRACTION m ³ /hr	360m ³ /hr	330m ³ /hr
POWER WATTAGE	40W	
VOLTAGE	220-240Va.c. 50Hz	
MATERIALS	Polypropylene housing	
CUTOUT SIZE	625 x 330mm	330 x 330mm Retro Fit Up to: 350 x 350mm
DECIBEL RATING	≤40dB	
IP RATING	IPX4	
HEATING WATTAGE / TYPE	2200W PTC	
LIGHTING WATTAGE / TYPE	18W LED	
COLOUR TEMPERATURE	3000K / 4000K / 5000K	
LUMENS OUTPUT	1080lm / 1190lm / 1140lm	1200lm / 1190lm / 1180lm
MINIMUM CEILING DEPTH	200mm	
DUCTING SIZE	100mm	
ACCESSORIES INCLUDED	1x 1.5m duct 2x clips for ducting 1x external grille 1x 4 gang switch wall controller	

DIMENSIONS

FURNACE MBHF2200W **FURNACE MINI** MBHFM2200W*

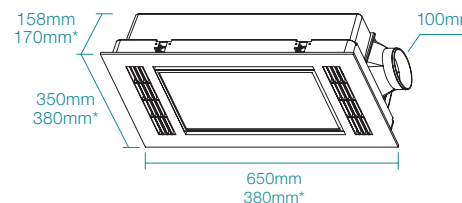

ACCESSORIES

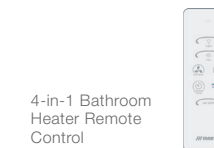

4-in-1 Bathroom Heater Remote Control

ACCESSORIES	ORDERING CODE
4-in-1 Bathroom Heater Remote Control	MBHPTKIT



PHOENIX

Slim and modern



FEATURES

- Sleek and low profile designed to suit any small to medium bathroom application
- Polypropylene (PP) housing with metal fascia
- Frosted white German high temperature Schott glass
- Built in thermal overload protection
- Back draft stopper included
- Cut-out template included
- Compatible with Martec Bathroom Remote Control MBHRKIT (not included)

PHOENIX



Matt White
MBHP1000W



Matt Black
MBHP1000M

SPECIFICATIONS	PHOENIX
AIR EXTRACTION m ³ /hr	500m ³ /hr
EXHAUST FAN WATTAGE	60W
VOLTAGE / FREQUENCY	220-240Va.c. 50Hz
MATERIALS / HOUSING	Polypropylene housing
CUTOUT SIZE	475 x 325mm
DECIBEL RATING	≤45dB
IP RATING	IPX2
HEATING WATTAGE / TYPE	1x 1000W R7s heat tube 238mm
LIGHTING WATTAGE / TYPE	20W LED
COLOUR TEMPERATURE	3000K / 4000K / 5000K
LUMENS OUTPUT	1585lm / 1695lm / 1585lm
MINIMUM CEILING DEPTH	220mm
DUCTING SIZE	150mm
ACCESSORIES INCLUDED	1x 1.5m duct 2x clips for ducting 1x external grille 1x 3 gang switch wall controller 1x heat tube

PHOENIX MINI



Matt White
MBHPM1000W



Matt Black
MBHPM1000M

SPECIFICATIONS	PHOENIX MINI
AIR EXTRACTION m ³ /hr	420m ³ /hr
EXHAUST FAN WATTAGE	60W
VOLTAGE / FREQUENCY	220-240Va.c. 50Hz
MATERIALS / HOUSING	Polypropylene housing
CUTOOUT SIZE	390 x 325mm
DECIBEL RATING	≤45dB
IP RATING	IPX2
HEATING WATTAGE / TYPE	1x 1000W R7s heat tube 238mm
LIGHTING WATTAGE / TYPE	10W LED
COLOUR TEMPERATURE	3000K / 4000K / 5000K
LUMENS OUTPUT	750lm / 800lm / 750lm
MINIMUM CEILING DEPTH	220mm
DUCTING SIZE	125mm
ACCESSORIES INCLUDED	1x 1.5m duct 2x clips for ducting 1x external grille 1x 3 gang switch wall controller 1x heat tube

PHOENIX

ACCESSORIES



1000W R7s Heat Tube 238mm

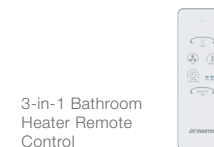

3-in-1 Bathroom Heater Remote Control

ACCESSORIES	ORDERING CODE
1000W R7s Heat Tube 238mm	MRLP1000W
3-in-1 Bathroom Heater Remote Control	MBHRKIT

DIMENSIONS

PHOENIX

MBHP1000W
MBHP1000M

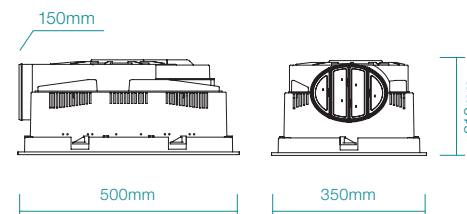

PHOENIX MINI

MBHPM1000W
MBHPM1000M

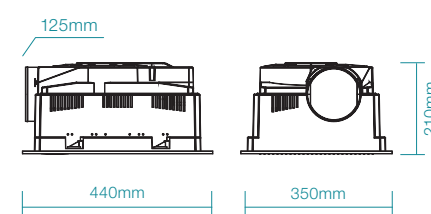

ASPIRE II

Seamless and discreet

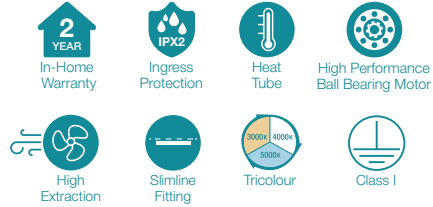

Matt White
MBHA1000W

FEATURES

- Sleek and low profile designed to suit any small to medium bathroom application
- Polypropylene housing with aluminium housing fascia
- Frosted white German high temperature Schott glass
- Built in thermal overload protection
- Back draft stopper included
- Cut-out template included
- Compatible with Martec Bathroom Remote Control MBHRKIT (not included)

SPECIFICATIONS	ASPIRE II
AIR EXTRACTION m ³ /hr	500m ³ /hr
EXHAUST FAN WATTAGE	60W
VOLTAGE / FREQUENCY	220-240Va.c. 50Hz
MATERIALS / HOUSING	Polypropylene housing
CUTOUT SIZE	475 x 325mm
DECIBEL RATING	≤45dB
IP RATING	IPX2
HEATING WATTAGE / TYPE	1x 1000W R7s heat tube 238mm
LIGHTING WATTAGE / TYPE	20W LED
COLOUR TEMPERATURE	3000K / 4000K / 5000K
LUMENS OUTPUT	2200lm / 2400lm / 2200lm
MINIMUM CEILING DEPTH	220mm
DUCTING SIZE	150mm
ACCESSORIES INCLUDED	1x 1.5m duct 2x clips for ducting 1x external grille 1x 3 gang switch wall controller 1x heat tube

ACCESSORIES



ACCESSORIES	ORDERING CODE
1000W R7s Heat Tube 238mm	MRLP1000W
3-in-1 Bathroom Heater Remote Control	MBHRKIT

DIMENSIONS

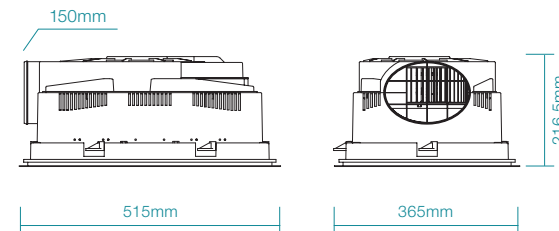

FORME

Contemporary design meets comfort



Matt White
MBHF4LW



Matt White
MBHF2LW

FEATURES

- Low profile design to suit any small to medium bathroom application
- Polypropylene (PP) housing with polycarbonate (PC) fascia
- Built in thermal overload protection
- Back draft stopper included
- Half heat function (4 heat unit only)
- Cut-out template included
- Compatible with Martec Bathroom Remote Control MBHRKIT (not included)

SPECIFICATIONS	FORME 2	FORME 4
AIR EXTRACTION m ³ /hr		420m ³ /hr
EXHAUST FAN WATTAGE		45W
VOLTAGE / FREQUENCY		220-240Va.c. 50Hz
MATERIALS / HOUSING		Polypropylene housing
CUTOUT SIZE	375 x 202mm	320 x 320mm
DECIBEL RATING		≤40dB
IP RATING		IPX4
HEATING WATTAGE / TYPE	2 x 275W heat lamps	4 x 275W heat lamps
LIGHTING WATTAGE / TYPE		10W LED
COLOUR TEMPERATURE		3000K / 4000K / 5000K
LUMENS OUTPUT		600lm / 725lm / 700lm
MINIMUM CEILING DEPTH		200mm
DUCTING SIZE		125mm
ACCESSORIES INCLUDED	1x 1.5m duct 2x clips for ducting 1x external grille 1x 3 gang switch wall controller 2x heat lamps	1x 1.5m duct 2x clips for ducting 1x external grille 1x 4 gang switch wall controller 4x heat lamps

ACCESSORIES

275W E27
Heat Lamp



3-in-1 Bathroom
Heater Remote
Control



ACCESSORIES

275W E27 Heat Lamp

3-in-1 Bathroom Heater Remote Control

ORDERING CODE

MRL275W

MBHRKIT

DIMENSIONS

FORME 2

MBHF2LW

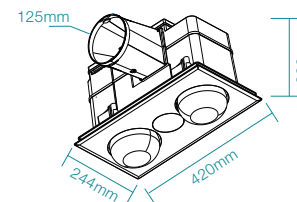

FORME 4

MBHF4LW

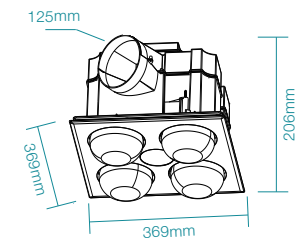

STRIKER

Universal warmth and comfort



Matt White
MBHS4LW



Matt White
MBHS2LW

FEATURES

- Low profile design to suit any small to medium bathroom application
- Polypropylene (PP) housing with polycarbonate (PC) fascia
- Built in thermal overload protection
- Back draft stopper included
- Half heat function (4 heat unit only)
- Cut-out template included
- Compatible with Martec Bathroom Remote Control MBHRKIT (not included)

SPECIFICATIONS	STRIKER 2	STRIKER 4
AIR EXTRACTION m ³ /hr		360m ³ /hr
EXHAUST FAN WATTAGE		35W
VOLTAGE / FREQUENCY		220-240Va.c. 50Hz
MATERIALS / HOUSING		Polypropylene housing
CUTOUT SIZE	375 x 202mm	320 x 320mm
DECIBEL RATING		≤40dB
IP RATING		IPX4
HEATING WATTAGE / TYPE	2 x 275W heat lamps	4 x 275W heat lamps
LIGHTING WATTAGE / TYPE		12W R80 LED tricolour
COLOUR TEMPERATURE		3000K / 4000K / 5000K
LUMENS OUTPUT		1100lm / 1200lm / 1100lm
MINIMUM CEILING DEPTH		200mm
DUCTING SIZE		125mm
ACCESSORIES INCLUDED	1x 1.5m duct 2x clips for ducting 1x external grille 1x 3 gang switch wall controller 2x heat lamps 1x Tricolour R80 LED lamp	1x 1.5m duct 2x clips for ducting 1x external grille 1x 4 gang switch wall controller 4x heat lamps 1x Tricolour R80 LED lamp

ACCESSORIES



ACCESSORIES	ORDERING CODE
275W E27 Heat Lamp	MRL275W
12W R80 LED Tricolour Lamp	MRL345R80
3-in-1 Bathroom Heater Remote Control	MBHRKIT

DIMENSIONS

STRIKER 2
MBHS2LW

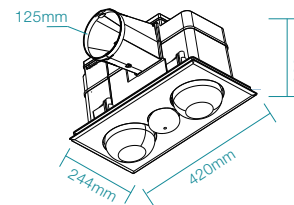

STRIKER 4
MBHS4LW

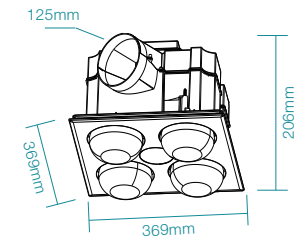

ESSENCE

Registered Design

Versatile and elegant



Matt White
MBHE4LW



Matt White
MBHE2LW

FEATURES

- Low profile design to suit any small to medium bathroom application
- Polypropylene (PP) housing with polycarbonate (PC) fascia
- Built in thermal overload protection
- Back draft stopper included
- Half heat function (4 heat unit only)
- Cut-out template included
- Compatible with Martec Bathroom Remote Control MBHRKIT (not included)

SPECIFICATIONS	ESSENCE 2	ESSENCE 4
AIR EXTRACTION m ³ /hr		300m ³ /hr
EXHAUST FAN WATTAGE		35W
VOLTAGE / FREQUENCY		220-240Va.c. 50Hz
MATERIALS / HOUSING		Polypropylene housing
CUTOUT SIZE	375 x 202mm	320 x 320mm
DECIBEL RATING		≤40dB
IP RATING		IPX4
HEATING WATTAGE / TYPE	2 x 275W heat lamps	4 x 275W heat lamps
LIGHTING WATTAGE / TYPE		9W R63 LED
COLOUR TEMPERATURE		4000K
LUMENS OUTPUT		900lm
MINIMUM CEILING DEPTH		200mm
DUCTING SIZE		125mm
ACCESSORIES INCLUDED	1x 1m duct 2x clips for ducting 1x external grille 1x 3 gang switch wall controller 2x heat lamps 1x 4000K R63 LED lamp	1x 1m duct 2x clips for ducting 1x external grille 1x 4 gang switch wall controller 4x heat lamps 1x 4000K R63 LED lamp

ACCESSORIES



ACCESSORIES	ORDERING CODE
275W E27 Heat Lamp	MRL275W
9W R63 LED 4000K Lamp	MRL4KR63
3-in-1 Bathroom Heater Remote Control	MBHRKIT

DIMENSIONS

ESSENCE 2 MBHE2LW

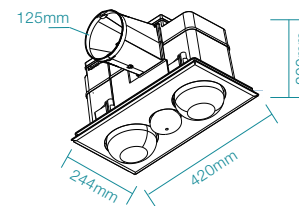

ESSENCE 4 MBHE4LW

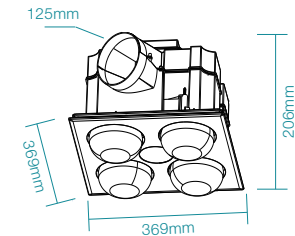

CONTOUR

Designer performance



In-Home Warranty*



Replacement Warranty**



Ingress Protection



High Performance Ball Bearing Motor



Heat Lamp



High Extraction



Class I



Matt White
MBHC4LW*



Matt White
MBHC2LW*



Matt White
MBHC1LW**

FEATURES

- Modern design to suit any small to medium bathroom application
- Polypropylene (PP) housing with polycarbonate (PC) fascia
- Built in thermal overload protection
- Back draft stopper included
- Half heat function (4 heat unit only)
- Cut-out template included
- Compatible with Martec Bathroom Remote Control MBHRKIT (not included) (excludes Contour 1)

*2 Year In-Home Warranty (MBHC2LW & MBHC4LW)

**1 Year Replacement Warranty (MBHC1LW)

SPECIFICATIONS	CONTOUR 1	CONTOUR 2	CONTOUR 4
AIR EXTRACTION m ³ /hr	-	240m ³ /hr	250m ³ /hr
EXHAUST FAN WATTAGE	-	30W	30W
VOLTAGE / FREQUENCY	220-240Va.c. 50Hz		
MATERIALS / HOUSING	Polypropylene housing		
CUTOUT SIZE	166 x 166mm	390 x 220mm	300 x 300mm
DECIBEL RATING	-	≤40dB	≤40dB
IP RATING	IPX2		
HEATING WATTAGE / TYPE	1 x 275W heat lamps	2 x 275W heat lamps	4 x 275W heat lamps
LIGHTING WATTAGE / TYPE	-	8W R80 E27 LED	8W R80 E27 LED
COLOUR TEMPERATURE	-	3000K	3000K
LUMENS OUTPUT	-	800lm	800lm
MINIMUM CEILING DEPTH	220mm		
DUCTING SIZE	-	100mm	100mm
ACCESSORIES INCLUDED	1x heat lamp	1x 1.5m duct 2x clips for ducting 1x external grille 1x 3 gang switch wall controller 2x heat lamps	1x 1.5m duct 2x clips for ducting 1x external grille 1x 4 gang switch wall controller 4x heat lamps

ACCESSORIES



275W E27 Heat Lamp

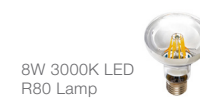

8W 3000K LED R80 Lamp

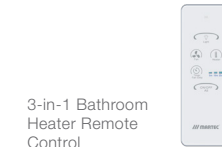

3-in-1 Bathroom Heater Remote Control

ACCESSORIES	ORDERING CODE
275W E27 Heat Lamp	MRL275W
8W 3000K LED R80 Lamp	MRL3K8W
3-in-1 Bathroom Heater Remote Control	MBHRKIT

DIMENSIONS

CONTOUR 1
MBHC1LW

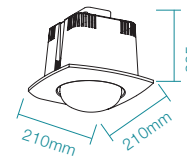

CONTOUR 2
MBHC2LW

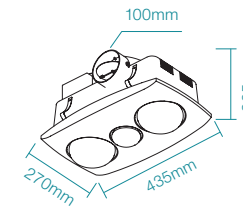

CONTOUR 4
MBHC4LW

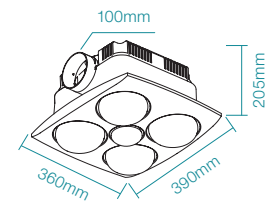

UNO

Focused performance



Matt White
MBHU1LW

FEATURES

- Slimline profile ideal for installation in ensuites and small bathrooms
- Provides powerful instant heating
- Aluminium housing with metal fascia trim
- Non dimmable

SPECIFICATIONS	UNO
VOLTAGE / FREQUENCY	220-240Va.c. 50Hz
MATERIALS / HOUSING	Aluminium housing
CUTOUT SIZE	Dia 145mm
IP RATING	IPX4
HEATING WATTAGE / TYPE	1x 275W heat lamp
LIGHTING WATTAGE / TYPE	1x 275W heat lamp
MINIMUM CEILING DEPTH	300mm
ACCESSORIES INCLUDED	1x heat lamp

ACCESSORIES



275W E27
Heat Lamp

ACCESSORIES	ORDERING CODE
275W E27 Heat Lamp	MRL275W

DIMENSIONS

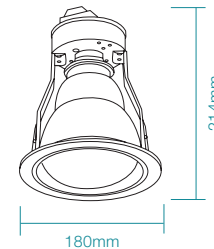



EXHAUST FANS

Martec® offers a versatile range of exhaust fans designed to suit a variety of spaces, including bathrooms and laundries. Available in multiple sizes and styles, the range includes models with integrated tricolour LED lighting and various IPX ratings to suit different installation environments and design preferences.

Powered by high-performance motors, Martec® exhaust fans provide strong air extraction while maintaining quiet and reliable operation. For added convenience, many models include a flex and plug for quick and simple installation, making Martec® exhaust fans a practical and dependable ventilation solution for any home.

NEW

CORE

Simple but powerful



- 
 2 YEAR
 Replacement
 Warranty
- 
 DIY
 Installation
- 
 IPX2
 Ingress
 Protection
- 
 Ultra Low
 Profile
- 
 Class II

FEATURES

- Classic design exhaust fan
- High air-extraction
- Quiet operation
- Polypropylene (PP) housing and fascia
- DIY flex and plug supplied for easy installation

CORE



Matt White
MXFC20W
MXFC25W

SPECIFICATIONS	MXFC20W	MXFC25W
AIR EXTRACTION m ³ /hr	310m ³ /hr	540m ³ /hr
POWER WATTAGE	25W	35W
VOLTAGE	220-240Va.c. 50Hz	
MATERIALS	Polypropylene housing	
CUTOUT SIZE	240mm	290mm
DECIBEL RATING	≤40dB	≤50dB
IP RATING	IPX2	
MINIMUM CEILING DEPTH	220mm	
ACCESSORIES INCLUDED	1x 1m flex & plug	

DIMENSIONS

CORE
MXFC20W

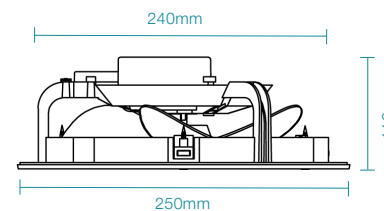

CORE
MXFC25W

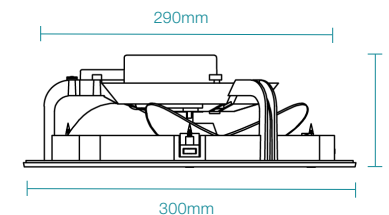

NEW

COMET DC

DC Power and Efficiency



Replacement
Warranty



Ingress
Protection



Ultra Low
Profile



Class II

FEATURES

- Low profile design ideal for installation in bathrooms, laundry and any residential and apartment applications
- High Performance DC Motor
- Polycarbonate body finished with a gloss white fascia
- Easy installation clamps to fit and secure fan into the ceiling
- High velocity exhaust fan with back draft stopper
- Features a concealed 15W or 18W Tricolour LED panel light



COMET DC



Matt White
MXFCR20W
MXFCR25W



Matt White
MXFCLR20W
MXFCLR25W

SPECIFICATIONS	COMET 240	COMET 295
AIR EXTRACTION m ³ /hr	390m ³ /hr	520m ³ /hr
EXHAUST FAN WATTAGE	20W	25W
VOLTAGE / FREQUENCY	220-240Va.c. 50Hz	
MATERIALS / HOUSING	Polypropylene housing	
CUTOOUT SIZE	Dia 240mm	Dia 295mm
DECIBEL RATING	≤45dB	
IP RATING	IPX4	
LIGHTING WATTAGE / TYPE	15W LED	18W LED
COLOUR TEMPERATURE	3000K / 4000K / 5000K	
LUMENS OUTPUT	890lm / 1000lm / 940lm	1070lm / 1180lm / 1130lm
MINIMUM CEILING DEPTH	220mm	
DUCTING SIZE	100mm	150mm

DIMENSIONS

COMET 240

MXFCR20W
MXFCLR20W

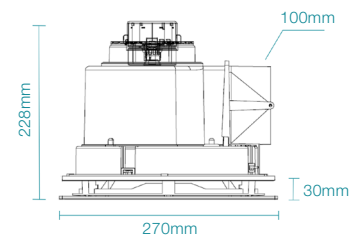

COMET 295

MXFCR25W
MXFCLR25W

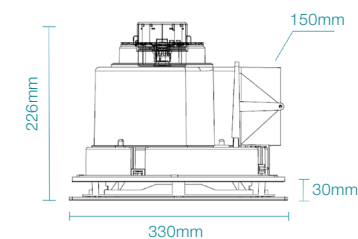



FLOW

All-rounder Performance



2 YEAR
Replacement
Warranty



IPX2
Ingress
Protection



Ultra Low
Profile



Class I
295 Model Only



Class II
240 Model Only



Matt Finish
Fascia

FEATURES

- Low profile design ideal for installation in bathroom, laundry and any residential and apartments application
- Swivel quick mount base for easy installation
- Polypropylene (PP) housing with ABS fascia
- Built in thermal overload protection
- Side ducting access with draft stopper included
- Round cutout ducting pipe for easy installation



Matt White
MXFFR25W
MXFFR30W



Matt White
MXFFS25W
MXFFS30W



Matt White
MXFLFR25W
MXFLFR30W



Matt White
MXFLFS25W
MXFLFS30W

FLOW

SPECIFICATIONS	ROUND 240	ROUND 295	SQUARE 240	SQUARE 295
AIR EXTRACTION m ³ /hr	390m ³ /hr	600m ³ /hr	390m ³ /hr	600m ³ /hr
EXHAUST FAN WATTAGE	45W	60W	45W	60W
VOLTAGE / FREQUENCY	220-240Va.c. 50Hz			
MATERIALS / HOUSING	Polypropylene housing			
CUTOUT SIZE	Dia 240mm	Dia 295mm	Dia 240mm	Dia 295mm
DECIBEL RATING	≤40dB			
IP RATING	IPX2			
LIGHTING WATTAGE / TYPE	12W LED Tricolour			
COLOUR TEMPERATURE	3000K / 4000K / 5000K			
LUMENS OUTPUT	950lm / 1000lm / 950lm			
MINIMUM CEILING DEPTH	210mm	240mm	210mm	240mm
DUCTING SIZE	125mm	150mm	125mm	150mm
ACCESSORIES INCLUDED	900mm flex & plug x 1pc			

DIMENSIONS

FLOW 240

MXFFR25W
MXFFS25W

FLOW LED 240

MXFLFR25W
MXFLFS25W

FLOW 295

MXFFR30W
MXFFS30W

FLOW LED 295

MXFLFR30W
MXFLFS30W

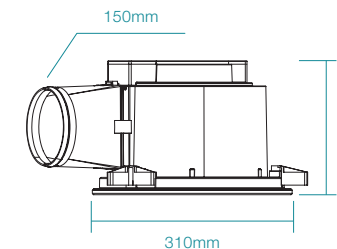
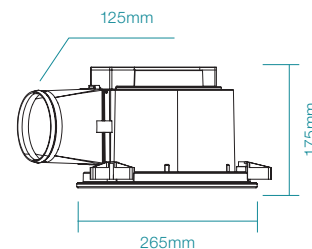



SATURN

Modern and Powerful



FEATURES

- Low profile design ideal for installation in bathroom, laundry and any residential and apartments application
- Polypropylene (PP) housing with white fascia plate
- Easy installation clamps to fit and secure fan into ceiling
- High velocity exhaust fan with back draft stopper
- Round cutout ducting pipe for easy installation



Matt White
MXFSR20W
MXFSR25W



Matt White
MXFSS20W
MXFSS25W



Matt White
MXFSLR20W
MXFSLR25W

SATURN

SPECIFICATIONS	ROUND 240	ROUND 295	SQUARE 240	SQUARE 295
AIR EXTRACTION m ³ /hr	320m ³ /hr	443m ³ /hr	320m ³ /hr	443m ³ /hr
EXHAUST FAN WATTAGE	30W	40W	30W	40W
VOLTAGE / FREQUENCY	220-240Va.c. 50Hz			
MATERIALS / HOUSING	Polypropylene housing			
CUTOOUT SIZE	Dia 240mm	Dia 295mm	Dia 240mm	Dia 295mm
DECIBEL RATING	≤45dB			
IP RATING	IPX4			
LIGHTING WATTAGE / TYPE	17W LED tricolour			-
COLOUR TEMPERATURE	3000K / 4000K / 5000K			-
LUMENS OUTPUT	1200lm / 1400lm / 1200lm	900lm / 1050lm / 900lm	-	
MINIMUM CEILING DEPTH	220mm			
DUCTING SIZE	100mm	150mm	100mm	150mm
ACCESSORIES INCLUDED	900mm flex & plug x 1pc			

DIMENSIONS

SATURN 240 **SATURN LED 240**
MXFSR20W MSFSLR20W*
MXFSS20W

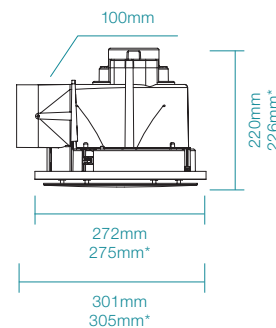

SATURN 295 **SATURN LED 295**
MXFSR25W MXFSLR25W*
MXFSS25W

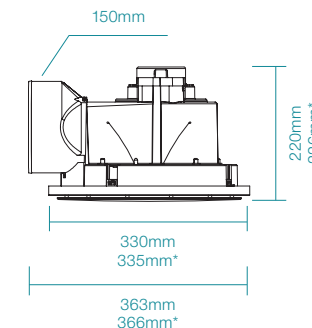



NEW

EXTERIOR HEATERS

Extend your outdoor living season with our premium exterior heaters, designed to deliver powerful, instant warmth exactly where you need it. Combining sleek, modern design with high-performance heating technology, they create a comfortable and inviting atmosphere for patios, alfresco areas, and covered outdoor spaces. Built for durability and weather resistance, our heaters perform reliably in the elements while maintaining a refined aesthetic. With efficient radiant heat, easy installation, and low-maintenance operation, they're the perfect solution for year-round outdoor comfort.

NEW

INFRASTRIP

Instant Heating and Comfort

- 2 YEAR Replacement Warranty
- IP65 Rating
- 2200W Heat Tube
- Class I

FEATURES

- Delivers instant high-efficient infrared heat
- IP65 rated for waterproof protection suitable for covered outdoor application
- Produces a comfortable 2200W instant radiant heat
- Supplied with a 6 stage heat remote control
- Compatible with Martec Freestanding Mounting Stand MEHSTAND (sold seperately)

INFRASTRIP



White
MEHI2000W



Matt Black
MEHI2000M



Supplied With
Remote Control

SPECIFICATIONS	INFRASTRIP
POWER WATTAGE	2200W Infrared heat tube
VOLTAGE	220-240Va.c. 50Hz
MATERIALS	Aluminium
IP RATING	IP65 Covered Outdoor
COVERAGE	Up to 12 Square Meters
ACCESSORIES INCLUDED	1x wall mount bracket control 1x screw pack 1x remote control

DIMENSIONS

INFRASTRIP

MEHI2000W
MEHI2000M

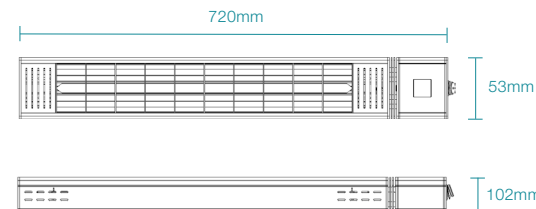

ACCESSORIES



Freestanding
Mounting Bracket

ACCESSORIES	ORDERING CODE
Freestanding Mounting Bracket	MEHSTAND



NEW

THERMOHEAT

All-Weather Warmth

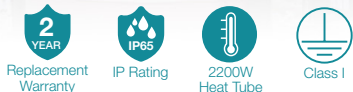

FEATURES

- Delivers instant high-efficient infrared heat
- IP65 rated for waterproof protection suitable for covered outdoor application
- Features a durable aesthetic ceramic glass
- Produces a comfortable 2200W instant radiant heat
- WiFi connectivity and operates via Martec Smart application
- Supplied with a 6 stage heat remote control
- Compatible with Martec Freestanding Mounting Stand MEHSTAND (sold separately)

THERMOHEAT



White
MEHT2000W



Supplied With
Remote Control



Matt Black
MEHT2000M

SPECIFICATIONS	THERMOHEAT
POWER WATTAGE	2200W Infrared heat tube
VOLTAGE	220-240Va.c. 50Hz
MATERIALS	Aluminium
IP RATING	IP65 Outdoor
COVERAGE	Up to 12 Square Meters
ACCESSORIES INCLUDED	1x steel wall mount bracket 1x screw pack 1x remote control

DIMENSIONS

INFRASTRIP

MEHT2000W
MEHT2000M

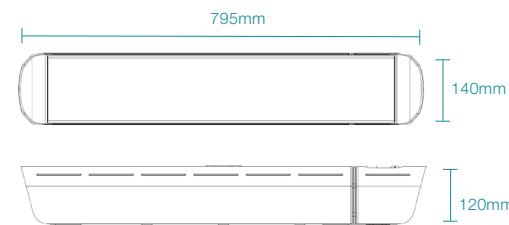

ACCESSORIES

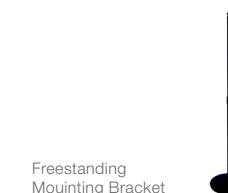

Freestanding
Mounting Bracket

ACCESSORIES	ORDERING CODE
Freestanding Mounting Bracket	MEHSTAND



HEATING ACCESSORIES

Martec® provides a selection of accessories that are fully compatible with our bathroom heaters, ensuring a seamless and enhanced experience. Remote controls allow for effortless operation of all unit function from anywhere in the room. Timers add an extra layer of energy efficiency, enabling users to schedule heating or ventilation cycles to run only when needed. Replacement lamps ensure that your lighting and heating functions are maintained over time. Together, these accessories make controlling comfort and functionality in your bathroom simple and hassle-free.

ACCESSORIES

NEW

3-in-1 BATHROOM HEATER REMOTE CONTROL KIT

MBHRKIT

FEATURES

- Easy to use with touch buttons
- Frequency range up to 30m
- Power capacity up to 2200W
- 5, 10, 25 minutes run timer
- Compatible with Martec 3-in-1 bathroom heaters
- Full or half heater function (4 heat unit only)

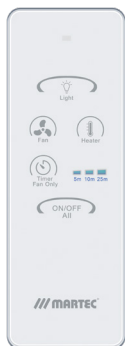

NEW

RUN ON TIMER

MBHTIMER

FEATURES

- Easy to install with connection wires
- 1 to 25 min run timer adjustable via rotary knob
- Power capacity up to 200W
- Operating temperature: -10 to 60



NEW

4-in-1 BATHROOM HEATER REMOTE CONTROL KIT

MBHPTKIT

FEATURES

- Easy to use with touch buttons
- Frequency range up to 30m
- Power capacity up to 2200W
- 5, 10, 25 minutes run timer
- Compatible with all Martec PTC bathroom heaters



NEW

FREESTANDING MOUNTING BRACKET

MEHSTAND

FEATURES

- Freestanding for easy installation
- Height adjustable
- Heavy duty base for stable installation



LAMPS



1000W R7s Heat Tube 238mm

MRLP1000W



6W GU10 LED Tricolour

MBGU34506



12W R80 LED Tricolour

MRL345R80



9W R63 LED 4000K

MRL4KR63



8W R80 LED 3000K

MRL3K8W



275W E27 Heat Lamp

MRL275W

LAMP	ORDERING CODE	COMPATIBLE PRODUCT
1000W R7s Heat Tube 238mm	MRLP1000W	Linux DC & Linux Mini DC, Phoenix & Phoenix Mini, Aspire II
6W GU10 LED Tricolour Lamp	MBGU34506	Linux DC & Linux Mini DC, Profile Plus DC
12W R80 LED Tricolour Lamp	MRL345R80	Striker
9W R63 LED 4000K Lamp	MRL4KR63	Essence
8W R80 LED 3000K Lamp	MRL3K8W	Contour
275W E27 Heat Lamp	MRL275W	All Bathroom Heaters + Profile Panel DC, Profile Plus DC



6 Austool Place Ingleburn NSW 2565
(02) 8778 7500
sales@martec.com.au

Opening Hours (Mon-Fri):
Warehouse: 7:30am – 3:30pm
Office: 8:00am – 4:00pm

www.martec.com.au

