

Quest LED Oyster Light Installation Guide

We strongly recommend that you read this manual carefully before installation.
Installation **MUST** be carried out by a qualified and licensed electrician.



Replacement
Warranty

Models Parameters:

- MLQO18W Quest 225mm LED Oyster Light 18w Dimmable Tricolour White
- MLQO24W Quest 300mm LED Oyster Light 24w Dimmable Tricolour White
- MLQO30W Quest 350mm LED Oyster Light 30w Dimmable Tricolour White

Installation Instructions

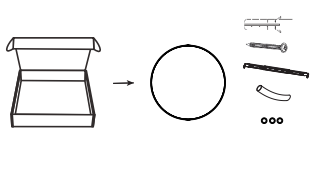

Step 1: Take out the panel light and accessory pack from the box.
Accessory pack including:
1x Installation Guide and Bracket,
3x Screws & Silicone washer,
2x Plastic expansion plug, 1x Heat shrink tubing.

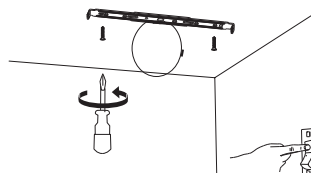

Step 2: Mount the bracket to the ceiling.
If the ceiling surface is uneven, place the silicone washer between the ceiling and the bracket to ensure a secure and level installation.

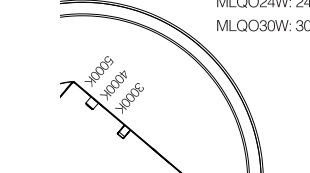

Step 3: Select the desired color temperature.

MLQO18W: 18W
MLQO24W: 24W
MLQO30W: 30W

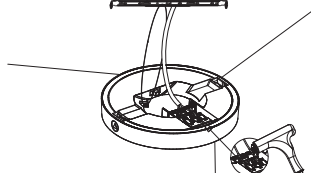

Step 4: The safety rope is secured with one end fastened to the bracket and the other end hooked onto the fixture's rear cover.
Use the heat shrink tubing from the tool kit to cover the AC input wires. Connect the live (L) and neutral (N) wires to the terminal box.

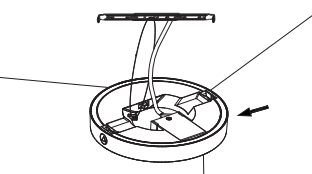

Step 5: Close the terminal box cover and tighten the screws to ensure strain relief.

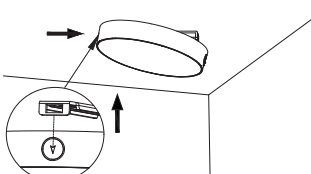

Step 6: Push upward either side of the fixture marked with the "unlock" symbol until the rear clips engage and lock onto the bracket.

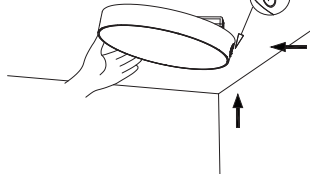

Step 7: Gently support the fixed side with one hand, then push up the other side of the fixture until the bracket hooks onto it as well. A "click" sound indicates the fixture is securely installed.

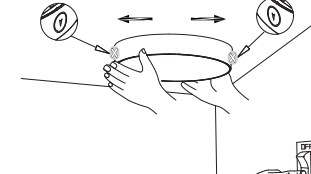

Step 8: Gently shake the fixture to check stability, avoid touching the sides marked with the "unlock" symbol. Ensure secure installation before powering on.

Deinstallation

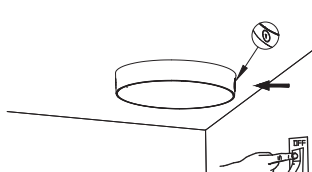

Step 1: Push inward either side of the light fixture with the "unlock symbol"

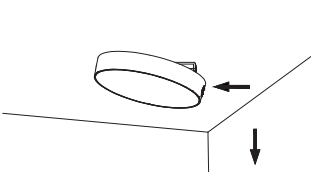

Step 2: Now gently pull down the pressed side of the luminaire and release it from the bracket.

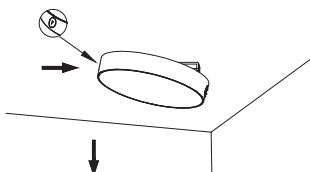

Step 3: Push inward on the opposite side of the fixture (also marked with the "unlock" symbol) to release it from the other side of the bracket.

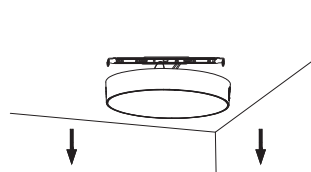

Step 4: Lower the fixture carefully until it is completely separated from the bracket.

Quest LED Oyster Light Installation Guide

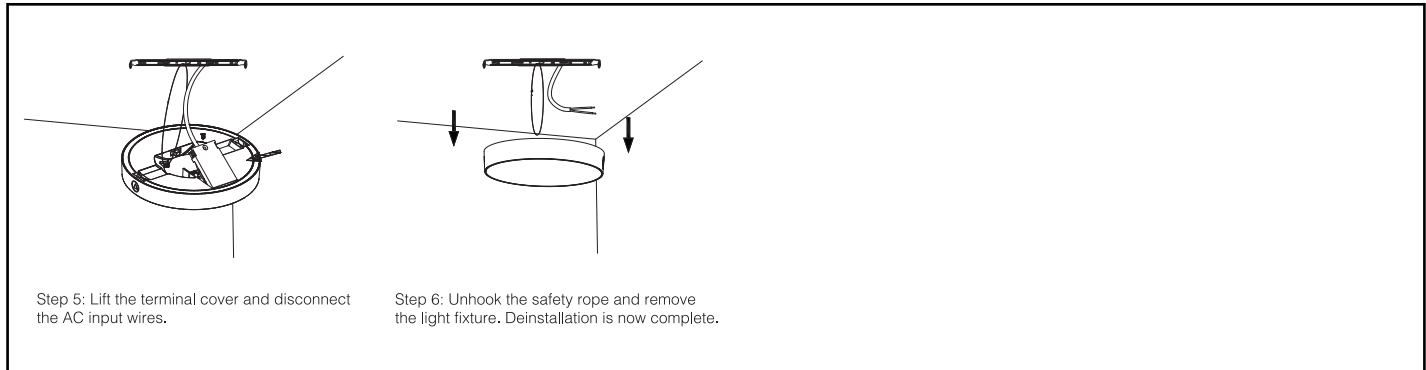

Data Table

| Models | Power (W) | PF | CCT (K) | Weight (KG) | Operation Temperature (Degree) | IP(Front) |
|---------|-----------|------|--------------------|-------------|--------------------------------|-----------|
| MLQO18W | 18 | ≥0.9 | 3000 / 4000 / 5000 | 0.46 | +40°-10° | 44 |
| MLQO24W | 24 | ≥0.9 | 3000 / 4000 / 5000 | 0.78 | +40°-10° | 44 |
| MLQO30W | 30 | ≥0.9 | 3000 / 4000 / 5000 | 1.05 | +40°-10° | 44 |

CCT (Colour Changable Temperature)

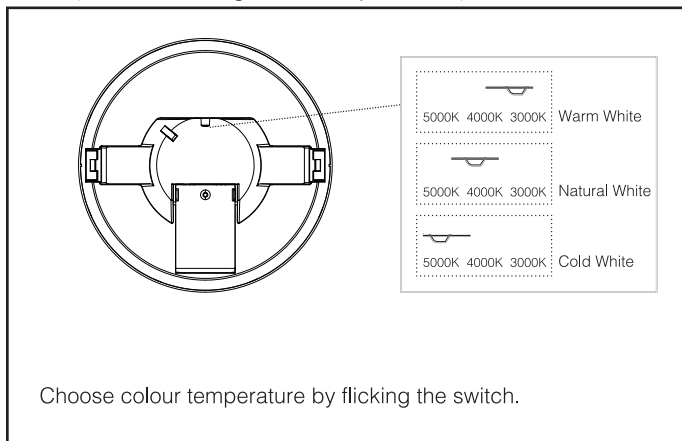

WARNING

- Installation of product **MUST** follow SAA standards and meet local authority regulations
- Installation **MUST** be carried out by a qualified and licensed electrician
- Light **MUST** be earthed
- Light **MUST** be firmly installed to a flat solid surface, wall or ceiling
- **DO NOT** immerse any part of the light fitting into water or any form of liquid
- **DO NOT** look directly into the LED light
- The warranty is **VOID** if product is not installed according to this installation guide

2 Year Replacement Warranty

Visit our website for details <https://www.martec.com.au/warranty-statement/>

E: sales@martecld.com.au
W: martec.com.au